

Read before assembly/installation

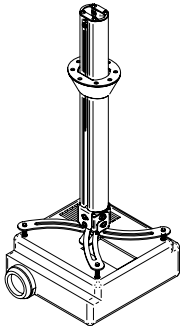

Please consult your projector's user manual or manufacturer's website for information on positioning your projector.

If you are unsure about installing this product or the setup up of your projector we recommend installation by a Professional AV Installer.

The Skyhook is packaged partially assembled.

Some disassembly and reassembly is required to install the product.

Parts List

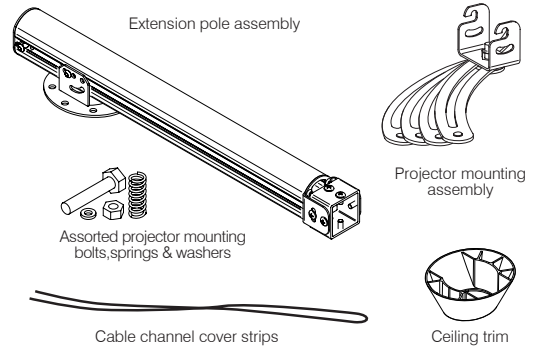

Attaching the Skyhook

Loosen the centre nut on the Projector mounting assembly and spread the mounting arms.

Adjust the arms to locate the hook into the centre of the projector and tighten all the bolts.

Mount the inverted projector to the arms using the bolts, washers and springs supplied.

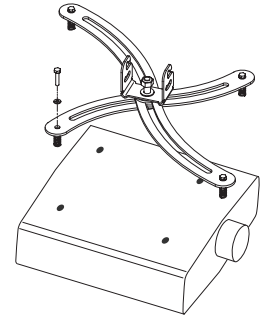

Note: Do not overtighten the bolts. If your projector only has 3 mounting points, discard 1 arm and reposition the hook into the centre of the projector.

Attaching the post assembly to the ceiling

The Skyhook can be set to suit different ceiling angles.

Remove the ceiling plate from the pole before attaching to the ceiling.

Re attach the pole at the desired angle.

The ceiling trim is suitable for flat ceiling mount and above ceiling mount only.

Fit cables through the Skyhook post.

Fit cover strips to finish.

(Thin cables can be passed through side channels)

It is recommended that you keep the power and AV cables separate from each other to avoid interference.

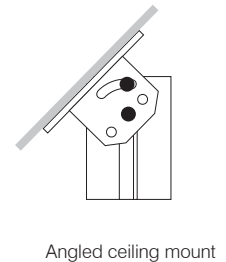
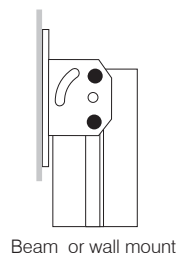
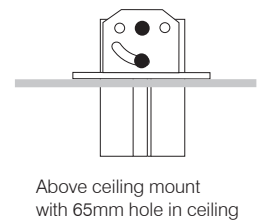
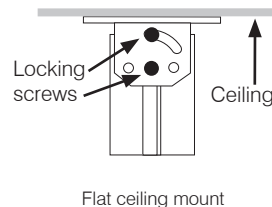

Attaching the projector

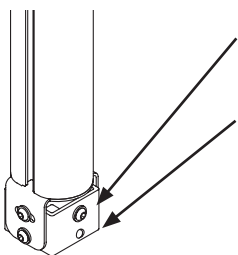

Loosen the top screw enough to hang the hook of the projector assembly over.

Remove the lower adjustment screw.

Hook the projector onto the top screw and reinsert the lower adjustment screw.

Adjust and tighten all screws.

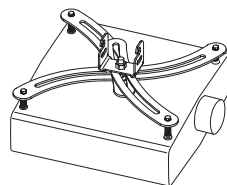

To shorten the adjustable post (optional feature) to length, remove the safety plate and cut from the ceiling side. Reassemble the unit including the safety plate.

